

RoHS GP HF

REV.	ECN MARK	ECN NO.	DESCRIPTION	DRAWN	DATE
A	⊗	/	NEW	ZHUCHAO	2022/04/26

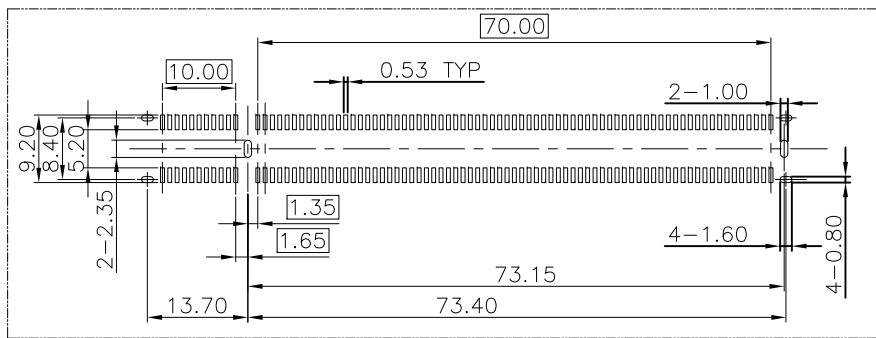

RECOMMENDED PCB LAYOUT  
DEFAULT TOLERANCE ±0.05

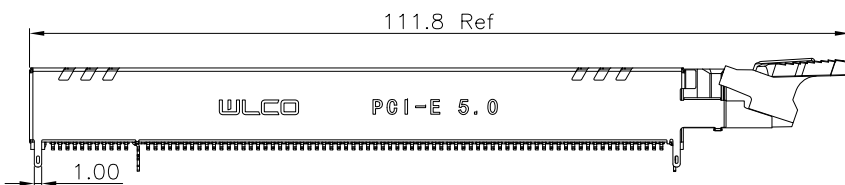
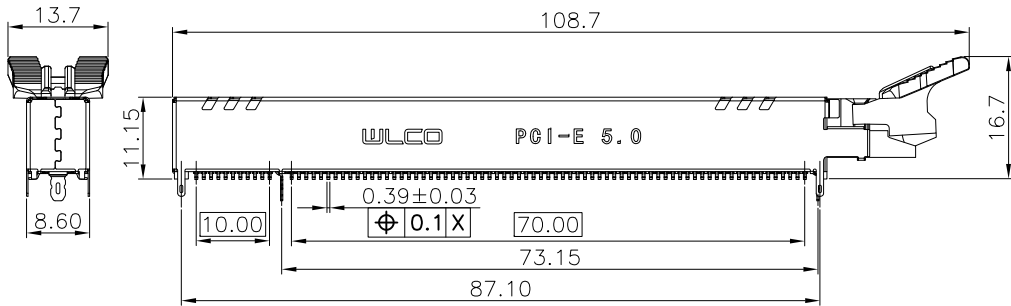
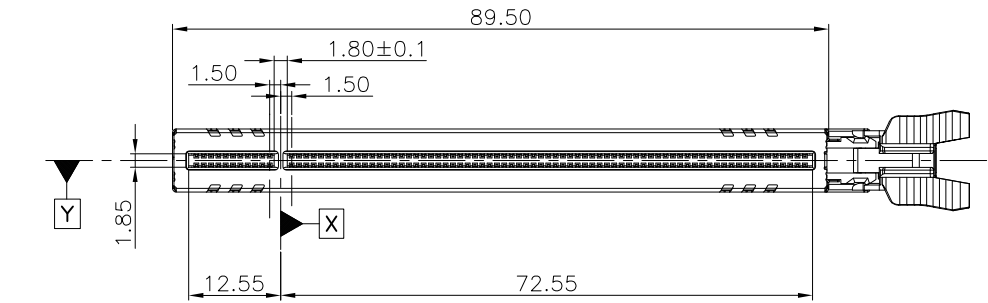
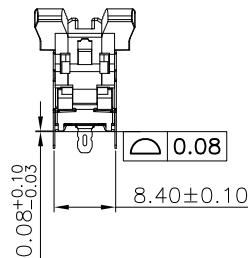
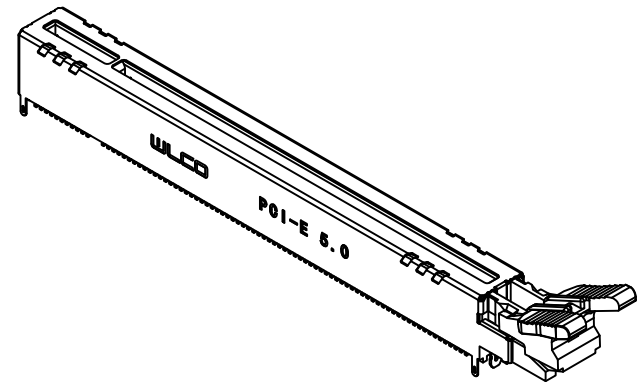

NOTE:

- ELECTRICAL PERFORMANCE
  - CURRENT RATING:1.1A PER PIN MAX;
  - LLCR:30mΩ MAX (INITIAL);
  - INSULATION RESISTANCE:500V DC,1000MΩ MIN;
  - DIELECTRIC WITHSTAND VOLTAGE:500V AC,0.5mA MAX;
- MECHANICAL PERFORMANCE
  - INSERTION FORCE-MODULE TO CONNECTOR:1.15N MAX PER PAIR;
  - DURABILITY:50 CYCLES;
  - UNMATING FORCE(PER PIN PAIR):0.15N MIN;
- RECOMMENDED CONDITION FOR SMT SOLDERING:
  - PEAK TEMPERATURE SHALL BE 260+/-5°C
  - DURATION 10±2 SECONDS.
- HF COMPLIANT

5	SHEEL	1	STAINLESS	
4	GROUND	1	STAINLESS	
3	HOOK	2	MEDIUM CARBON STEEL	
2	CONTACT	164	COPPER ALLOY	
1	HOUSING	1	HIGH TEMPERATURE THERMOPLASTIC	
ITEM	NAME	Q'TY	SPEC DESCRIPTION	REMARKS
TOLERANCE		MODEL NAME:	PCIE 164PIN,GEN5 SMT WITH SMALL LATCH	DRAWN:
X.X	±0.35	MODEL NO.:	SEE TABLE	ZHUCHAO
X.XX	±0.25	UNIT:	mm	CHECKED:
X.XXX	±0.10	SCALE:	1:1	YOUHUA.CAI
ANGLE	±2.0°	REVISION:	A	APPROVED:
		SHEET:	1/2	YOUHUA.CAI
		DATE:	2022/04/26	
			DWG NO:	C-WLPC-164P28
			FILE:	C

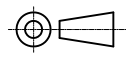

**WLCO** 深圳市兴万联电子有限公司  
SHENZHEN XING WAN LIAN ELECTRONICS CO., LTD.

RoHS GP HF

REV.	ECN MARK	ECN NO.	DESCRIPTION	DRAWN	DATE
A	⊗	/	NEW	ZHUCHAO	2022/04/26

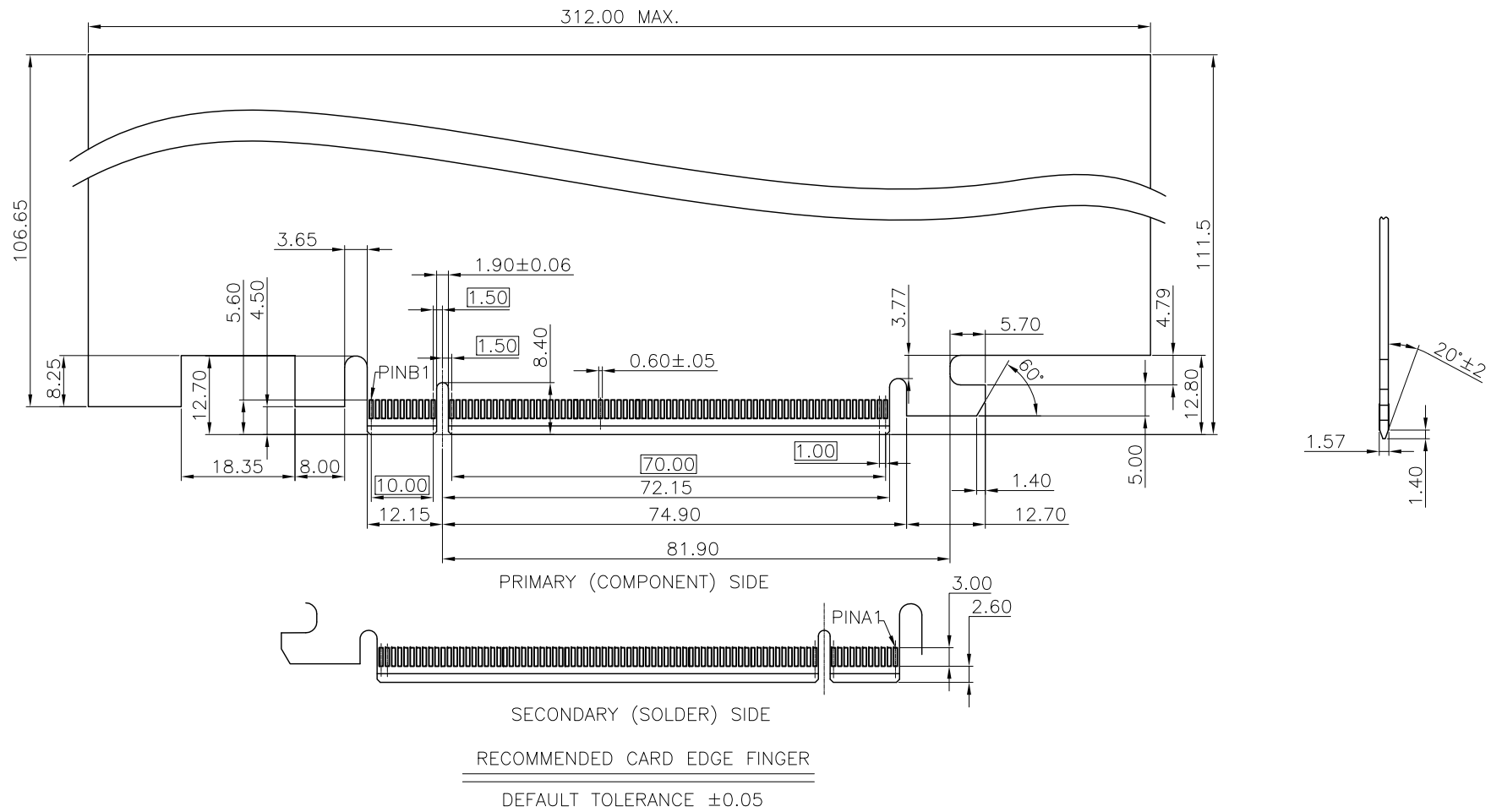

- NOTES:
- NO TIE PERMITTED FROM CARD EDGE TO LEADING EDGE OF PAD FOR PINS 'A1' AND 'C'.
  - CHAMFER EDGES MUST BE FREE OF CUTTING BURRS.

TOLERANCE X.X ±0.35 X.XX ±0.25 X.XXX ±0.10 ANGLE ±2.0°	MODEL NAME:	PCI-E 164PIN,GEN5 SMT WITH SMALL LATCH			DRAWN:	ZHUCHAO
	MODEL NO.:	SEE TABLE			CHECKED:	YOUHUA.CAI
	UNIT:	SCALE:	REVISION:	SHEET:	APPROVED:	YOUHUA.CAI
	mm	1:1	A	2/2	DATE:	2022/04/26
	WLCO 深圳市兴万联电子有限公司 SHENZHEN XING WAN LIAN ELECTRONICS CO.,LTD.				DWG NO.:	C-WLPC-164P28
					FILE:	C

1  
RoHS

GP

2  
HF

5	6	7	8
REV.	ECN MARK	ECN NO.	DESCRIPTION
A	⊗	/	NEW

A  
TABLE

NO.	PART NO.	SPECIFICATION	HSF COMPLIANT
1	WLPC-133A	HOUSING_PA10T BLACK UL94-V0,LATCH_PA10T BLACK,CONTACT_C5191 G/F Sn100u”,HOOK_S50C Sn100u”,SHELL Ni 50u”.	HF COMPLIANT

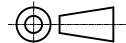
TOLERANCE X.X ±0.35 X.XX ±0.25 X.XXX ±0.10 ANGLE ±2.0°	MODEL NAME:	PCIE 164PIN,GEN5 SMT WITH SMALL LATCH			DRAWN:	ZHUCHAO	
	MODEL NO:	SEE TABLE			CHECKED:	YOUHUA.CAI	
	UNIT:	SCALE:	REVISION:	SHEET:	APPROVED:	YOUHUA.CAI	
	mm	1:1	A	1/1	DATE:	2022/04/26	
 <b>WLCO</b> 深圳市兴万联电子有限公司 SHENZHEN XING WAN LIAN ELECTRONICS CO.,LTD.		DWG NO:	C-WLPC-133A			FILE:	C